

OMRON

Automatic Blood Pressure Monitor

Model HEM-7142T1
Instruction Manual



5653096-1C
Issue Date: 2022-05-26

All for Healthcare

Table of Contents

- Introduction
- Important Safety Information
 1. Know Your Monitor
 2. Preparation
 3. Using Your Monitor without a Smart Device
 4. Using Your Monitor with a Smart Device
 5. Using Memory Function
 6. Other Settings
 7. Error Messages and Troubleshooting
 8. Maintenance
 9. Optional Medical Accessories
 10. Other Optional Parts
 11. Specifications
 12. Guidance and Manufacturer's Declaration

Introduction

Thank you for purchasing the OMRON Automatic Blood Pressure Monitor. This blood pressure monitor uses the oscillometric method of blood pressure measurement. This means this monitor detects your blood movement through your brachial artery and converts the movements into a digital reading.

Safety Instructions

This instruction manual provides you with important information about the OMRON Automatic Blood Pressure Monitor. To ensure the safe and proper use of this monitor, READ and UNDERSTAND all of these instructions. If you do not understand these instructions or have any questions, contact your local OMRON representative before attempting to use this monitor. For specific information about your own blood pressure, consult with your physician.

Intended Use

This device is a digital monitor intended for use in measuring blood pressure and pulse rate in the adult patient population. This monitor detects the appearance of irregular heartbeats during measurement and indicates this via a symbol with measurement result. It is mainly designed for general household use.

Receiving and Inspection

Remove this monitor from the packaging and inspect for damage. If this monitor is damaged, DO NOT USE and consult with your local OMRON representative.

Important Safety Information

Read the Important Safety Information in this instruction manual before using this monitor. Follow this instruction manual thoroughly for your safety. Keep for future reference. For specific information about your own blood pressure, CONSULT WITH YOUR PHYSICIAN.

Warning

Indicates a potentially hazardous situation which, if not avoided, could result in death or serious injury.

- DO NOT use this monitor on infants, toddlers, children or persons who cannot express themselves.
- DO NOT adjust medication based on readings from this blood pressure monitor. Take medication as prescribed by your physician. ONLY a physician is qualified to diagnose and treat high blood pressure.
- DO NOT use this monitor on an injured arm or an arm under medical treatment.
- DO NOT apply the arm cuff on your arm while on an intravenous drip or blood transfusion.
- DO NOT use this monitor in areas containing high frequency (HF) surgical equipment, magnetic resonance imaging (MRI) equipment, computerized tomography (CT) scanners. This may result in incorrect operation of the monitor and/or cause an inaccurate reading.
- DO NOT use this monitor in oxygen rich environments or near flammable gas.
- Consult with your physician before using this monitor if you have common arrhythmias such as atrial or ventricular premature beats or atrial fibrillation; arterial sclerosis; poor perfusion; diabetes; pregnancy; pre-eclampsia or renal disease. NOTE that any of these conditions in addition to patient motion, trembling, or shivering may affect the measurement reading.
- NEVER diagnose or treat yourself based on your readings. ALWAYS consult with your physician.
- To help avoid strangulation, keep the air tube and AC adapter cable away from infants, toddlers and children.
- This product contains small parts that may cause a choking hazard if swallowed by infants, toddlers and children.

Data Transmission

- This product emits radio frequencies (RF) in the 2.4 GHz band. DO NOT use this product in locations where RF is restricted, such as on an aircraft or in hospitals. Turn off the Bluetooth® feature in this monitor, remove batteries and/or unplug the AC adapter when in RF restricted areas.

AC Adapter (optional accessory) Handling and Usage

- Fully insert the AC adapter into the outlet.
- When unplugging the AC adapter from the outlet, be sure to safely pull from the AC adapter. DO NOT pull from the AC adapter cable.
- When handling the AC adapter cable: DO NOT damage it. DO NOT break it. DO NOT tamper with it. DO NOT pinch it. DO NOT forcibly bend or pull it. DO NOT twist it. DO NOT use it if it is gathered in a bundle. DO NOT place it under heavy objects.
- Wipe any dust off of the AC adapter.
- Unplug the AC adapter when not in use.
- Unplug the AC adapter before cleaning this monitor.

Battery Handling and Usage

- DO NOT insert batteries with their polarities incorrectly aligned.
- ONLY use 4 "AA" alkaline or manganese batteries with this monitor. DO NOT use other types of batteries. DO NOT use new and used batteries together. DO NOT use different brands of batteries together.
- Remove batteries if this monitor will not be used for a long period of time.
- If battery fluid should get in your eyes, immediately rinse with plenty of clean water. Consult with your physician immediately.
- If battery fluid should get on your skin, wash your skin immediately with plenty of clean, lukewarm water. If irritation, injury or pain persists, consult with your physician.

- DO NOT disassemble or attempt to repair the AC adapter.
- Battery Handling and Usage
- Keep batteries out of the reach of infants, toddlers and children.

Caution

Indicates a potentially hazardous situation which, if not avoided, may result in minor or moderate injury to the user or patient, or cause damage to the equipment or other property.

- Stop using this monitor and consult with your physician if you experience skin irritation or discomfort.
- Consult with your physician before using this monitor on an arm where intravascular access or therapy, or an arteriovenous (A-V) shunt, is present because of temporary interference to blood flow and could result in injury.
- Consult with your physician before using this monitor if you have had a mastectomy.
- Consult with your physician before using this monitor if you have severe blood flow problems or blood disorders as cuff inflation can cause bruising.

- DO NOT take measurements more often than necessary because bruising, due to blood flow interference, may occur.
- ONLY inflate the arm cuff when it is applied on your upper arm.
- Remove the arm cuff if it does not start deflating during a measurement.
- DO NOT use this monitor for any purpose other than measuring blood pressure.
- During measurement, make sure that no mobile device or any other electrical device that emit electromagnetic fields is within 30 cm of this monitor. This may result in incorrect operation of the monitor and/or cause an inaccurate reading.
- DO NOT disassemble or attempt to repair this monitor or other components. This may cause an inaccurate reading.
- DO NOT use in a location where there is moisture or a risk of water splashing this monitor. This may damage this monitor.
- DO NOT use this monitor in a moving vehicle such as in a car or on an aircraft.
- DO NOT drop or subject this monitor to strong shocks or vibrations.
- DO NOT use this monitor in places with high or low humidity or high or low temperatures. Refer to section 11.

- During measurement, observe the arm to ensure that the monitor is not causing prolonged impairment to blood circulation.
- DO NOT use this monitor in high-use environments such as medical clinics or physician offices.
- DO NOT use this monitor with other medical electrical (ME) equipment simultaneously. This may result in incorrect operation of the devices and/or cause an inaccurate reading.
- Avoid bathing, drinking alcohol or caffeine, smoking, exercising and eating for at least 30 minutes before taking a measurement.
- Rest for at least 5 minutes before taking a measurement.
- Remove tight-fitting or thick clothing from your arm while taking a measurement.
- Remain still and DO NOT talk while taking a measurement.
- ONLY use the arm cuff on persons whose arm circumference is within the specified range of the cuff.
- Ensure that this monitor has acclimated to room temperature before taking a measurement. Taking a measurement after an extreme temperature change could lead to an inaccurate reading. OMRON recommends waiting for approximately 2 hours for the monitor to warm up or cool down when the monitor is used in an environment within the temperature specified as operating conditions after it is stored either at the maximum or at the minimum storage temperature. For additional information on operating and storage/transport temperature, refer to section 11.

- DO NOT use this monitor after the durable period has ended. Refer to section 11.
- DO NOT crease the arm cuff or the air tube excessively.
- DO NOT fold or kink the air tube while taking a measurement. This may cause an injury by interrupting blood flow.
- To unplug the air plug, pull on the plastic air plug at the base of the tube, not the tube itself.
- ONLY use the AC adapter, arm cuff, batteries and accessories specified for this monitor. Use of unsupported AC adapters, arm cuffs and batteries may damage and/or may be hazardous to this monitor.
- ONLY use the approved arm cuff for this monitor. Use of other arm cuffs may result in incorrect readings.
- Inflating to a higher pressure than necessary may result in bruising of the arm where the cuff is applied. NOTE: refer to "If your systolic pressure is more than 210 mmHg" in section 3 of this instruction manual for additional information.

Refer to section 11 for information on room temperature acclimation.

Important Safety Information

Read the Important Safety Information in this instruction manual before using this monitor. Follow this instruction manual thoroughly for your safety. Keep for future reference. For specific information about your own blood pressure, CONSULT WITH YOUR PHYSICIAN.

Warning

Indicates a potentially hazardous situation which, if not avoided, could result in death or serious injury.

- DO NOT use this monitor on infants, toddlers, children or persons who cannot express themselves.
- DO NOT adjust medication based on readings from this blood pressure monitor. Take medication as prescribed by your physician. ONLY a physician is qualified to diagnose and treat high blood pressure.
- DO NOT use this monitor on an injured arm or an arm under medical treatment.
- DO NOT apply the arm cuff on your arm while on an intravenous drip or blood transfusion.
- DO NOT use this monitor in areas containing high frequency (HF) surgical equipment, magnetic resonance imaging (MRI) equipment, computerized tomography (CT) scanners. This may result in incorrect operation of the monitor and/or cause an inaccurate reading.
- DO NOT use this monitor in oxygen rich environments or near flammable gas.
- Consult with your physician before using this monitor if you have common arrhythmias such as atrial or ventricular premature beats or atrial fibrillation; arterial sclerosis; poor perfusion; diabetes; pregnancy; pre-eclampsia or renal disease. NOTE that any of these conditions in addition to patient motion, trembling, or shivering may affect the measurement reading.
- NEVER diagnose or treat yourself based on your readings. ALWAYS consult with your physician.
- To help avoid strangulation, keep the air tube and AC adapter cable away from infants, toddlers and children.
- This product contains small parts that may cause a choking hazard if swallowed by infants, toddlers and children.

Data Transmission

- This product emits radio frequencies (RF) in the 2.4 GHz band. DO NOT use this product in locations where RF is restricted, such as on an aircraft or in hospitals. Turn off the Bluetooth® feature in this monitor, remove batteries and/or unplug the AC adapter when in RF restricted areas.

AC Adapter (optional accessory) Handling and Usage

- Fully insert the AC adapter into the outlet.
- When unplugging the AC adapter from the outlet, be sure to safely pull from the AC adapter. DO NOT pull from the AC adapter cable.
- When handling the AC adapter cable: DO NOT damage it. DO NOT break it. DO NOT tamper with it. DO NOT pinch it. DO NOT forcibly bend or pull it. DO NOT twist it. DO NOT use it if it is gathered in a bundle. DO NOT place it under heavy objects.
- Wipe any dust off of the AC adapter.
- Unplug the AC adapter when not in use.
- Unplug the AC adapter before cleaning this monitor.

Battery Handling and Usage

- DO NOT insert batteries with their polarities incorrectly aligned.
- ONLY use 4 "AA" alkaline or manganese batteries with this monitor. DO NOT use other types of batteries. DO NOT use new and used batteries together. DO NOT use different brands of batteries together.
- Remove batteries if this monitor will not be used for a long period of time.
- If battery fluid should get in your eyes, immediately rinse with plenty of clean water. Consult with your physician immediately.
- If battery fluid should get on your skin, wash your skin immediately with plenty of clean, lukewarm water. If irritation, injury or pain persists, consult with your physician.

- DO NOT use batteries after their expiration date.
- Periodically check batteries to ensure they are in good working condition.

1. Know Your Monitor

1.1 Contents/Product Includes
Monitor, arm cuff, 4 "AA" batteries, instruction manual, setup instructions, warranty card

1.2 Monitor and Arm Cuff

Front of the monitor

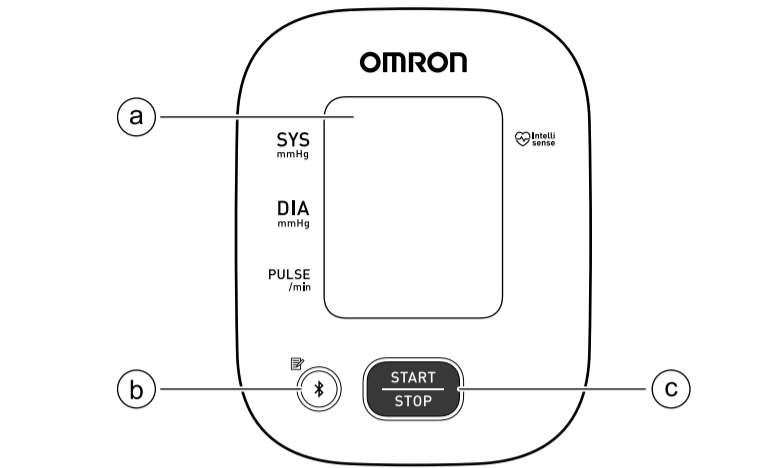

- a Display
- b [Connection] button (Memory)
- c [START/STOP] button

Left side, back and bottom of the monitor

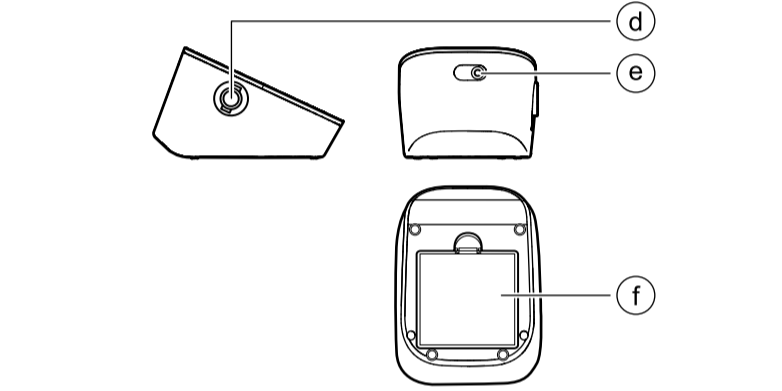

- d Air jack
- e AC adapter jack (for optional AC adapter)
- f Battery compartment

Arm cuff (Upper arm circumference: 22 - 32 cm)



- g Air plug
- h Air tube

1.3 Display and Symbols

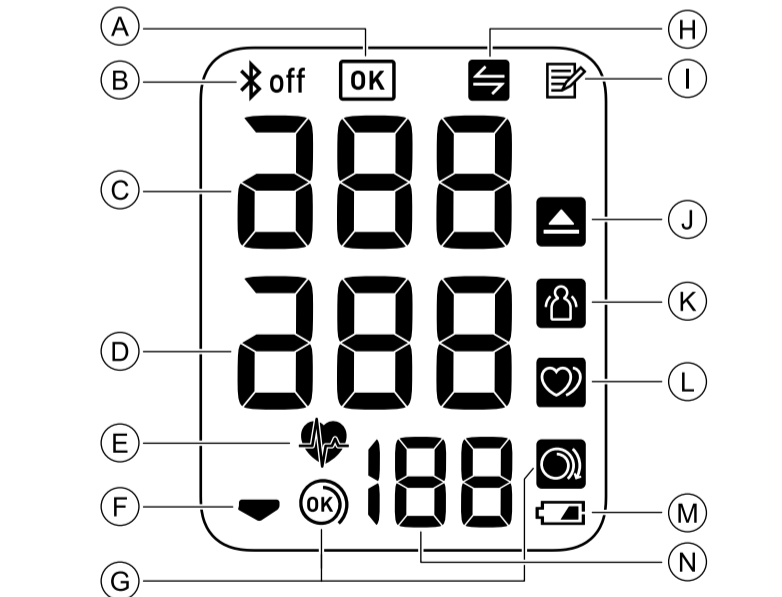

(A)		OK symbol Flashes when your monitor is connected to your smart device successfully.
(B)		Bluetooth ON symbol Appears when your readings are being transferred.
(B)		Bluetooth OFF symbol Appears when Bluetooth is disabled.
(C)		Systolic blood pressure reading
(D)		Diastolic blood pressure reading
(E)		Heartbeat symbol Flashes while taking a measurement.
(F)		Deflation symbol Appears during cuff deflation.
(G)		Cuff wrap guide symbol (OK) Appears if the arm cuff is wrapped around the arm correctly while taking a measurement. It also appears when viewing past readings.
(G)		Cuff wrap guide symbol (loose) Appears if the arm cuff is not wrapped around the arm correctly while taking a measurement. It also appears when viewing past readings.
(H)		Sync symbol Flashes/appears when your data needs to be transferred because the stored memory is either almost, or completely full. Once you pair your monitor with your smart device, transfer your readings immediately before the monitor deletes the oldest reading. Up to 14 readings can be stored in the internal memory of your monitor.
(I)		Memory symbol Appears when viewing readings stored in the memory.
(J)		Hypertension symbol Appears if your systolic blood pressure is 135 mmHg or above and/or the diastolic blood pressure is 85 mmHg or above.
(K)		Movement error symbol Appears with your reading when your body is moving during a measurement. If it appears, remove the arm cuff and wait for 2 to 3 minutes. Then, reapply the cuff, remain still and take another measurement.
(L)		Irregular heartbeat symbol Appears when irregular rhythm is detected 2 or more times during a measurement. An irregular heartbeat rhythm is defined as a rhythm that is 25% less or 25% more than the average rhythm detected while your monitor is measuring blood pressure.  Irregular heartbeat symbol may be displayed when the monitor detects arm movements. Refer to section 7 for more information. If it continues to appear, we recommend you to consult with and follow the directions of your physician.
(M)		Low battery symbol Flashes when batteries are low.
(M)		Depleted battery symbol Appears when batteries are depleted.
(N)		Pulse display / Memory number Pulse rate appears after the measurement. When pressing the (c) button, the memory number appears for approximately 1.5 seconds before the pulse rate shows again on the display.

2018 ESH/ESC* Guidelines for the management of arterial hypertension

Definitions of hypertension by office and home blood pressure levels

	Office	Home
Systolic Blood Pressure	≥ 140 mmHg	≥ 135 mmHg
Diastolic Blood Pressure	≥ 90 mmHg	≥ 85 mmHg

These ranges are from statistical values for blood pressure.

* European Society of Hypertension (ESH) and European Society of Cardiology (ESC).

Warning

•NEVER diagnose or treat yourself based on your readings. ALWAYS consult with your physician.

2. Preparation

2.1 Installing Batteries

1. Push down on the hook of the battery cover and pull upward.
2. Insert 4 "AA" batteries as indicated in the battery compartment.
3. Close the battery cover.

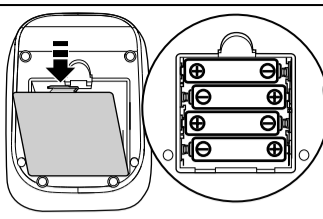

Note

- When the " " symbol flashes on the display, it is recommended you replace batteries.
- To replace batteries, turn your monitor off and remove all batteries. Then replace with 4 new batteries at the same time.
- Replacing batteries will not delete previous readings.
- The supplied batteries may have a shorter life span than new batteries.
- Disposal of used batteries should be carried out in accordance with local regulations.

2.2 Blood Pressure Measurement Tips

- To help ensure an accurate reading, follow these directions:
 - Stress raises blood pressure. Avoid taking measurements during stressful times.
 - Measurements should be taken in a quiet place.
 - It is important to take measurements at the same times each day. Taking measurements in the morning and in the evening is recommended.
 - Remember to have a record of your blood pressure and pulse readings for your physician. A single measurement does not provide an accurate indication of your true blood pressure. You need to take and record several readings over a period of time.

Caution

- Avoid bathing, drinking alcohol or caffeine, smoking, exercising and eating for at least 30 minutes before taking a measurement.
- Rest for at least 5 minutes before taking a measurement.

2.3 Applying the Arm Cuff

Note

- The following steps are for applying the arm cuff to your left arm. When you take a measurement on your right arm, follow the cuff wrap instructions for a right arm use mentioned under "To take a measurement on your right arm" located at the end of this sub-section.
- The blood pressure can differ between the right arm and the left arm, and the measured blood pressure readings can be different. OMRON recommends to always use the same arm for measurement. If the readings between both arms differ substantially, check with your physician to determine as to which arm to use for your measurements.

Caution

- Remove tight-fitting or thick clothing from your arm while taking a measurement.

1. Plug the arm cuff into your monitor by inserting the air plug into the air jack securely until it clicks.

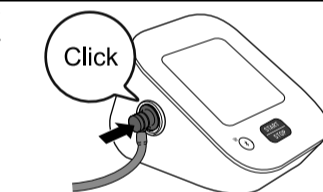

2. Place your hand through the cuff loop. Pull the cuff until it reaches your upper left arm.

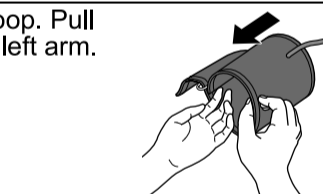

Note

- The bottom edge of the arm cuff should be 1 to 2 cm above the inside elbow. The air tube is on the inside of your arm and aligned with your middle finger.

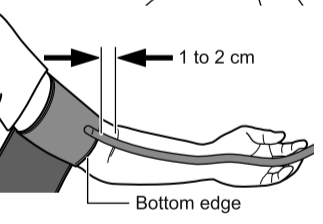

3. Make sure that the air tube is positioned on the inside of your arm and wrap the cuff securely, so it can not move around your arm.

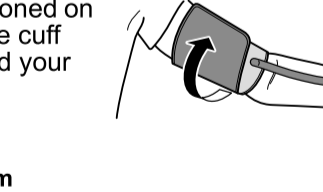

To take a measurement on your right arm

When you take a measurement on the right arm, the air tube should be at the side of your elbow. Be careful not to rest your arm on the air tube.



2.4 Sitting Correctly

To take a measurement, you need to be relaxed and comfortably seated in a room with a comfortable temperature. Place your arm on the table.

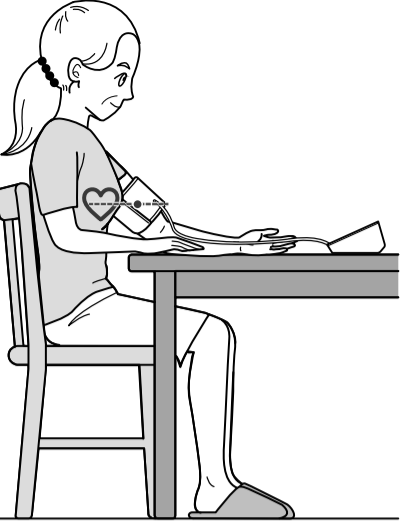

- Sit in a comfortable chair with your back and arm supported.
- Keep your feet flat and your legs uncrossed.
- The arm cuff should be placed on your arm at the same level as your heart, with the arm resting comfortably on a table.

3. Using Your Monitor without a Smart Device

3.1 Taking a Measurement

You can use your monitor without pairing to a smart device. To pair your monitor with a smart device, refer to sub-section 4.1.

Note

- To stop the measurement, press the [START/STOP] button once to deflate the arm cuff.

Caution

- DO NOT use this monitor with other medical electrical (ME) equipment simultaneously. This may result in incorrect operation of the devices and/or cause an inaccurate reading.
- Remain still and DO NOT talk while taking a measurement.

1. Press the [START/STOP] button. All symbols appear on the display before starting the measurement.

2. Remain still and do not talk until the entire measurement process is complete.

The " " symbol flashes at every heartbeat.

Note

- The " " symbol appears if the arm cuff is wrapped around the arm correctly.
- When the " " symbol is displayed, the arm cuff is not applied correctly. Press the [START/STOP] button to turn your monitor off, then apply the cuff correctly.

After your monitor has detected your blood pressure and pulse rate, the cuff automatically deflates. Your blood pressure and pulse rate are displayed.

If either the systolic or the diastolic reading is high (refer to sub-section 1.3), the " " symbol appears.

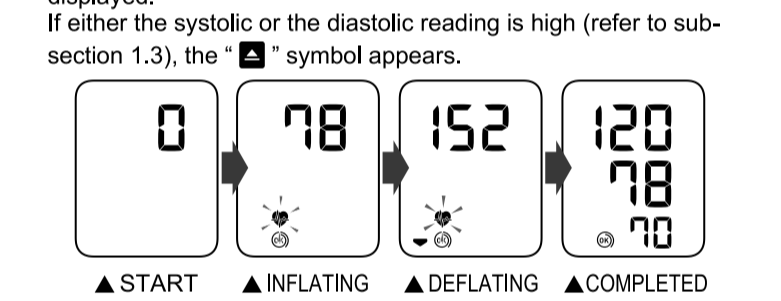

3. Press the [START/STOP] button to turn your monitor off.

Note

- Your monitor automatically turns off after 2 minutes.
- Wait 2 - 3 minutes between measurements. The wait time allows the arteries to decompress and return to their pre-measurement state. You may need to increase the wait time depending on your individual physiological characteristics.

If your systolic pressure is more than 210 mmHg

If your systolic pressure is more than 210 mmHg, take a measurement manually. After the arm cuff starts to inflate, press and hold the [START/STOP] button until the monitor inflates 30 to 40 mmHg higher than your expected systolic pressure.

Note

- Do not inflate above 299 mmHg.

Caution

- Inflating to a higher pressure than necessary may result in bruising of the arm where the cuff is applied.

4. Using Your Monitor with a Smart Device

4.1 Pairing Your Monitor with a Smart Device

Review the list of compatible smart devices at www.omronconnect.com/devices/

1. Enable Bluetooth on your smart device.
2. Download and install the "OMRON connect" app onto your smart device.



If you already have the "OMRON connect" app and have created your account, open the app and add your new monitor.

3. Open the app and follow the pairing instructions shown on your smart device.

4. Confirm that your monitor is connected successfully.

When your monitor is connected successfully to your smart device, the OK symbol appears.



5. Press the [START/STOP] button to turn your monitor off.

- Note**
 - If the "Err" symbol appears, follow the instructions in the "OMRON connect" app.
 - Your monitor automatically turns off after 10 seconds.
 - Be aware that OMRON will not be responsible for the loss of data and/or information in the app.
 - "OMRON connect" is the only app that we recommend to use with your monitor to transfer data correctly.

4.2 Taking a Measurement

Refer to sub-section 3.1 to start a measurement. Open the app on your smart device and follow the instructions.

Note

- Make sure that your monitor is within 5 m of your smart device.

Transferring Data Automatically

When Bluetooth is enabled, the readings will be transferred to your smart device after taking a measurement.

4.3 Disabling/Enabling Bluetooth

Disable Bluetooth in your monitor in the following areas where use of wireless equipment is prohibited.

- On aircraft • In hospitals • While aboard

5. Using Memory Function

Your monitor automatically stores up to 14 readings.

5.1 Viewing the Readings Stored in Memory

- Press the button.

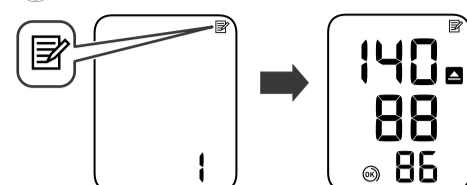

The Memory number appears for 1.5 seconds before the pulse rate is displayed. The most recent reading stored in the memory will be numbered as "1".

Note

- If the reading is high (refer to sub-section 1.3), the symbol appears.
- If there are no readings stored in the memory, the screen to the right is displayed.
- If the memory is full, new readings will replace the old readings, starting with the oldest reading.

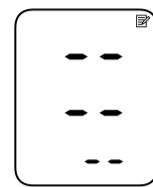

- Press the button repeatedly to scroll through the previous readings stored in the memory.

6. Other Settings

6.1 Restoring Your Monitor to the Default Settings

To delete all the information stored in your monitor, follow the instructions below. Make sure that your monitor is turned off.

- Press the button.

After a memory number appears, the latest reading will appear with a past reading.

- While holding the button down, press and hold the [START/STOP] button for more than 4 seconds.

The display to the right flashes.

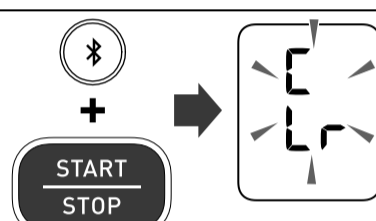

- While holding the button down again, press and hold the [START/STOP] button for more than 4 seconds.

The display stops flashing, then your monitor is restored to the default settings.

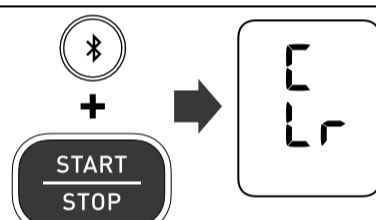

- Press the [START/STOP] button to turn your monitor off.

Note

- Reverting to the default setting of your monitor does not delete the information in the app.
- Your monitor automatically turns off after 10 seconds.

7. Error Messages and Troubleshooting

If any of the below problems occur during measurement, check to make sure that no other electrical device is within 30 cm. If the problem persists, please refer to the table below.

Display/Problem	Possible Cause	Solution
E1 appears or the arm cuff does not inflate.	The [START/STOP] button was pressed while the arm cuff is not applied.	Press the [START/STOP] button again to turn the monitor off.
	Air plug is not completely plugged into the monitor.	Insert the air plug securely.
	The arm cuff is not applied correctly.	Apply the arm cuff correctly, then take another measurement. Refer to sub-section 2.3.
E2 appears or a measurement cannot be complete after the arm cuff inflates.	Air is leaking from the arm cuff.	Replace the arm cuff to the new one. Refer to section 9.
	You move or talk during a measurement and the arm cuff does not inflate sufficiently.	Remain still and do not talk during a measurement. If "E2" appears repeatedly, inflate the arm cuff manually until the systolic pressure is 30 to 40 mmHg above your previous readings. Refer to sub-section 3.1.
E3 appears	The arm cuff is inflated exceeding the maximum allowable pressure.	Do not touch the arm cuff and/or bend the air tube while taking a measurement. If inflating the arm cuff manually, refer to sub-section 3.1.
	The pulse rate is not detected correctly.	Remain still and do not talk during a measurement. Vibrations disrupt a measurement.
E4 appears	You move or talk during a measurement. Vibrations disrupt a measurement.	Remain still and do not talk during a measurement.
E5 appears	The pulse rate is not detected correctly.	Apply the arm cuff correctly, then take another measurement. Refer to sub-section 2.3. Remain still and sit correctly during a measurement. If the symbol continues to appear, we recommend you to consult with your physician.
appears	The pulse rate is not detected correctly.	Apply the arm cuff correctly, then take another measurement. Refer to sub-section 2.3. Remain still and sit correctly during a measurement. If the symbol continues to appear, we recommend you to consult with your physician.
does not flash during a measurement	The pulse rate is not detected correctly.	Apply the arm cuff correctly, then take another measurement. Refer to sub-section 2.3. Remain still and sit correctly during a measurement. If the symbol continues to appear, we recommend you to consult with your physician.
Er appears	The monitor has malfunctioned.	Press the [START/STOP] button again. If "Er" still appears, contact your local OMRON representative.
E appears	The monitor cannot connect to a smart device or transmit data correctly.	Follow the instructions shown in the "OMRON connect" app. If the "Er" symbol still appears after checking the app, contact your local OMRON representative.
P flashes	The monitor is waiting for pairing with the smart device.	Refer to sub-section 4.1 for pairing your monitor with your smart device, or press the [START/STOP] button to cancel pairing and turn your monitor off.
flashes	More than 11 readings are not transferred.	Pair or transfer your readings to the "OMRON connect" app so you can keep them in memory in the app, and this error symbol disappears.
	Your monitor is not paired or not connected with your smart device.	Refer to sub-section 4.1 for pairing your monitor with your smart device, or press the [START/STOP] button to cancel pairing and turn your monitor off.
appears	There are 14 readings in memory to be transferred	Refer to sub-section 4.1 for pairing your monitor with your smart device, or press the [START/STOP] button to cancel pairing and turn your monitor off.
flashes	Batteries are low.	Replacing all 4 batteries with new ones is recommended. Refer to sub-section 2.1.
A! and appears or the monitor is turned off unexpectedly during a measurement.	Batteries are depleted.	Immediately replace all 4 batteries with new ones. Refer to sub-section 2.1.
	Batteries are depleted.	Check the battery installation for proper placement. Refer to sub-section 2.1.
Nothing appears on the display of the monitor.	Battery polarities are not properly aligned.	Check the battery installation for proper placement. Refer to sub-section 2.1.

Display/Problem	Possible Cause	Solution
Readings appear too high or too low.	Blood pressure varies constantly. Many factors including stress, time of day, and/or how you apply the arm cuff, may affect your blood pressure. Review sub-sections 2.2 - 2.4 and section 3.	
Any other communication issue occurs.	Follow the instructions shown in the smart device, or visit the "Help" section in the "OMRON connect" app for further help. If the problem still persists, contact your local OMRON representative.	
Any other problems occur.	Press the [START/STOP] button to turn the monitor off, then press it again to take a measurement. If the problem continues, remove all batteries and wait for 30 seconds. Then re-install batteries. If the problem still persists, contact your local OMRON representative.	

8. Maintenance

8.1 Maintenance

To protect your monitor from damage, follow the directions below:

- Changes or modifications not approved by the manufacturer will void the user warranty.

Caution

DO NOT disassemble or attempt to repair this monitor or other components. This may cause an inaccurate reading.

8.2 Storage

Store your monitor and other components in a clean, safe location.

- Remove the arm cuff from the monitor.

Caution

To unplug the air plug, pull on the plastic air plug at the base of the tube, not the tube itself.

- Gently fold the air tube into the arm cuff.

Note

- Do not bend or crease the air tube excessively.

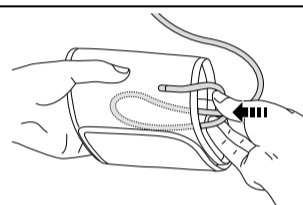

Do not store your monitor and other components:

- If your monitor and other components are wet.
- In locations exposed to extreme temperatures, humidity, direct sunlight, dust or corrosive vapors such as bleach.
- In locations exposed to vibrations or shocks.

8.3 Cleaning

- Do not use any abrasive or volatile cleaners.
- Use a soft dry cloth or a soft cloth moistened with mild (neutral) detergent to clean your monitor and arm cuff and then wipe them with a dry cloth.
- Do not wash or immerse your monitor and arm cuff or other components in water.
- Do not use gasoline, thinners or similar solvents to clean your monitor and arm cuff or other components.

8.4 Calibration and Service

- The accuracy of this blood pressure monitor has been carefully tested and is designed for a long service life.
- It is generally recommended to have the unit inspected every two years to ensure correct functioning and accuracy. Please consult your authorised OMRON dealer or the OMRON Customer Service at the address given on the packaging or attached literature.

9. Optional Medical Accessories



Medium Cuff
HEM-CR24
Type B
22 - 32 cm



Wide Range Soft Cuff
HEM-RML31
Type B
22 - 42 cm



Small Cuff
HEM-CS24
Type B
17 - 22 cm

Note

- Do not throw the air plug away. The air plug can be applicable to the optional cuff.



AC Adapter
HHP-CM01
HHP-BFH01 (For Sri Lanka)

Using the AC Adapter (optional accessory)

Note

- Make sure not to place your monitor in a location where it is difficult to plug and unplug the AC adapter.

- Insert the AC adapter plug into the AC adapter jack on the back side of your monitor.

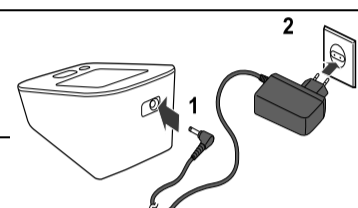

- Plug the AC adapter into an electrical outlet.

To unplug the AC adapter, unplug the AC adapter from the electrical outlet and then remove the AC adapter plug from the monitor.

Caution

ONLY use the AC adapter, arm cuff, batteries and accessories specified for this monitor. Use of unsupported AC adapters, arm cuffs and batteries may damage and/or may be hazardous to this monitor.

10. Other Optional Parts



AC Adapter
For Australia and New Zealand: HHP-OH01
For India: HHP-BH01

11. Specifications

Product description	Automatic Blood Pressure Monitor
Model	HEM-7142T1
Display	LCD digital display
Cuff pressure range	0 to 299 mmHg
Blood pressure measurement range	SYS: 60 to 260 mmHg DIA: 40 to 215 mmHg
Pulse measurement range	40 to 180 beats / min.
Accuracy	Pressure: ±3 mmHg Pulse: ±5% of display reading
Inflation	Automatic by electric pump
Deflation	Automatic pressure release valve
Measurement method	Oscillometric method
Transmission method	Bluetooth® Low Energy
Wireless communication	Frequency range: 2.4 GHz (2400 - 2483.5 MHz) Modulation: GFSK Effective radiated power: < 20 dBm
Operating mode	Continuous operation
IP classification	Monitor: IP20 Optional AC adapter: IP22 for HHP-OH01, HHP-BH01 and HHP-BFH01, IP21 for other AC adapters
Rating	DC6 V 4 W
Power source	4 "AA" batteries 1.5 V or optional AC adapter (INPUT AC 100 - 240 V 50 - 60 Hz 0.12 - 0.065 A)
Battery life	Approximately 900 measurements (Using new alkaline batteries and included arm cuff. Depending on the type of battery and arm cuff.)
Durable period (Service life)	Monitor: 5 years Arm cuff: 5 years Optional AC adapter: 5 years
Operating conditions	+10 to +40°C / 15 to 90% RH (non-condensing) / 800 to 1060 hPa
Storage / Transport conditions	-20 to +60°C / 10 to 90% RH (non-condensing)
Contents	Monitor, arm cuff, 4 "AA" batteries, instruction manual, setup instructions, warranty card
Protection against electric shock	Internally powered ME equipment (when using only batteries) Class II ME equipment (optional AC adapter)
Weight (not including batteries)	Monitor: approximately 250 g Arm cuff: approximately 110 g
Dimensions (approximately value)	Monitor: 103 mm (W) × 82 mm (H) × 140 mm (L) Arm cuff: 146 mm × 466 mm (air tube: 610 mm)
Cuff circumference applicable to the monitor	17 to 42 cm (included arm cuff: 22 to 32 cm)

Memory	Stores up to 14 readings
Applied part	Type BF (arm cuff)

Note

- These specifications are subject to change without notice.
- This monitor is clinically investigated according to the requirements of EN ISO 81060-2:2014 and complies with EN ISO 81060-2:2014 and EN ISO 81060-2:2019+A1:2020. In the clinical validation study, K5 was used on 85 subjects for determination of diastolic blood pressure.
- IP classification is degrees of protection provided by enclosures in accordance with IEC 60529. This monitor and optional AC adapter are protected against solid foreign objects of 12.5 mm diameter and greater such as a finger. The optional AC adapters (except for HHP-OH01, HHP-BH01 and HHP-BFH01) are protected against vertically falling water drops which may cause issues during a normal operation. The optional AC adapter HHP-OH01, HHP-BH01 and HHP-BFH01 are protected against oblique falling water drops which may cause issues during a normal operation.
- Operation mode is classification in accordance with IEC 60601-1.

About a wireless communication interference

This product operates in an unlicensed ISM band at 2.4 GHz. In the event this product is used near other wireless devices such as microwave and wireless LAN, which operate on the same frequency band as this product, there is a possibility that interference may occur. If interference occurs, stop the operation of the other devices or relocate this product away from other wireless devices before attempting to use it.

12. Guidance and Manufacturer's Declaration

CE 0197

- This blood pressure monitor is designed according to the European Standard EN1060, Non-invasive sphygmomanometers Part 1: General Requirements and Part 3: Supplementary requirements for electromechanical blood pressure measuring systems.
- Hereby, OMRON HEALTHCARE Co., Ltd., declares that the radio equipment type HEM-7142T1 is in compliance with Directive 2014/53/EU.
- The full text of the EU declaration of conformity is available at the following internet address: <https://www.omronhealthcare-ap.com/ap/support>
- This OMRON product is produced under the strict quality system of OMRON HEALTHCARE Co., Ltd., Japan. The Core component for OMRON blood pressure monitors, which is the Pressure Sensor, is produced in Japan.
- Please report to the manufacturer and the competent authority of the Member State in which you are established about any serious incident that has occurred in relation to this device.

Symbols description	Applied part - Type BF
	Degree of protection against electric shock (leakage current)
	CE Marking
	Class II equipment. Protection against electric shock
	Ingress protection degree provided by IEC 60529
	Serial number
	LOT number
	Medical Device
	For indoor use only
	Temperature limitation
	Humidity limitation
	Atmospheric pressure limitation
	Indication of connector polarity
	Identifier of cuffs compatible for the device
	OMRON's trademarked technology for blood pressure measurement
	Arm circumference
	Cuff positioning indicator for the left arm
	Marker on the cuff to be positioned above the artery
	Range pointer and brachial artery alignment position
	Range indicator of arm circumferences to help selection of the correct cuff size
	Need for the user to consult this instruction manual.
	Need for the user to follow this instruction manual thoroughly for your safety.

Symbols description	Applied part - Type BF
	Direct current
	Alternating current
	Date of manufacture
	To indicate generally elevated, potentially hazardous, levels of non-ionizing radiation, or to indicate equipment or systems e.g. in the medical electrical area that include RF transmitters or that intentionally apply RF electromagnetic energy for diagnosis or treatment.
	RCM compliance mark, which indicates compliance with electrical safety, EMC, EME & telecommunications requirements in Australia and New Zealand, as applicable to the product.
	BIS mark
	SMPS (Switch mode power supply unit)
	SMPS incorporating a short-circuit-proof safety isolating transformer (inherently or non-inherently)
	Efficiency level of power supply
	Not made with natural rubber latex

Important information regarding Electromagnetic Compatibility (EMC)

HEM-7142T1 manufactured by OMRON HEALTHCARE Co., Ltd. conforms to EN60601-1-2:2015 Electromagnetic Compatibility (EMC) standard. Further documentation in accordance with this EMC standard is available at: <https://www.omronhealthcare-ap.com/emc-information> Refer to the EMC information for HEM-7142T1 on the website.

Correct Disposal of This Product (Waste Electrical & Electronic Equipment)

This marking shown on the product or its literature, indicates that it should not be disposed of, with other household wastes at the end of its working life. To prevent possible harm to the environment or human health from uncontrolled waste disposal, please separate this product from other types of wastes and recycle it responsibly to promote the sustainable reuse of material resources.



Household users should contact either the retailer where they purchased this product, or their local government office, for details of where and how they can return this item for environmentally safe recycling. Business users should contact their supplier and check the terms and conditions of the purchase contract. This product should not be mixed with other commercial waste for disposal.

The Bluetooth® word mark and logos are registered trademarks owned by Bluetooth SIG, Inc. and any use of such marks by OMRON HEALTHCARE Co., Ltd. is under license. Other trademarks and trade names are those of their respective owners.

Apple and the Apple logo are trademarks of Apple Inc., registered in the U.S. and other countries and regions. App Store is a service mark of Apple Inc. Google Play and Google Play logo are trademarks of Google LLC.

<https://www.omronhealthcare-ap.com/>

Manufacturer	OMRON HEALTHCARE Co., Ltd. 53, Kunosubo, Terado-cho, Muko, KYOTO, 617-0002 JAPAN
EU-representative	OMRON HEALTHCARE EUROPE B.V. Scorpius 33, 2132 LR Hoofddorp, THE NETHERLANDS www.omron-healthcare.com
Importer in EU	
Asia Pacific HQ	OMRON HEALTHCARE SINGAPORE PTE LTD. www.omronhealthcare-ap.com
Production Facility	OMRON HEALTHCARE MANUFACTURING VIETNAM CO., LTD. No.28 VSIP II, Street 2, Vietnam-Singapore Industrial Park II, Binh Duong Industry-Services-Urban Complex, Hoa Phu Ward, Thu Dau Mot City, Binh Duong Province, Vietnam